

BACK PANEL OPTIONAL ON 1109
BACK PANEL STANDARD ON 1109BP

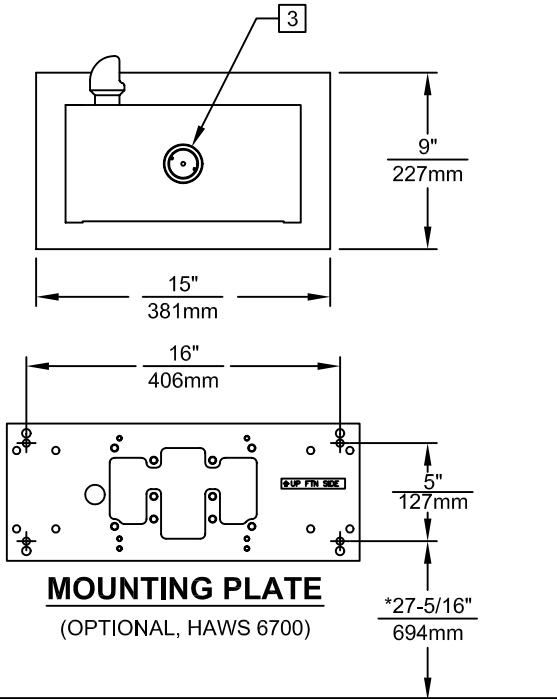
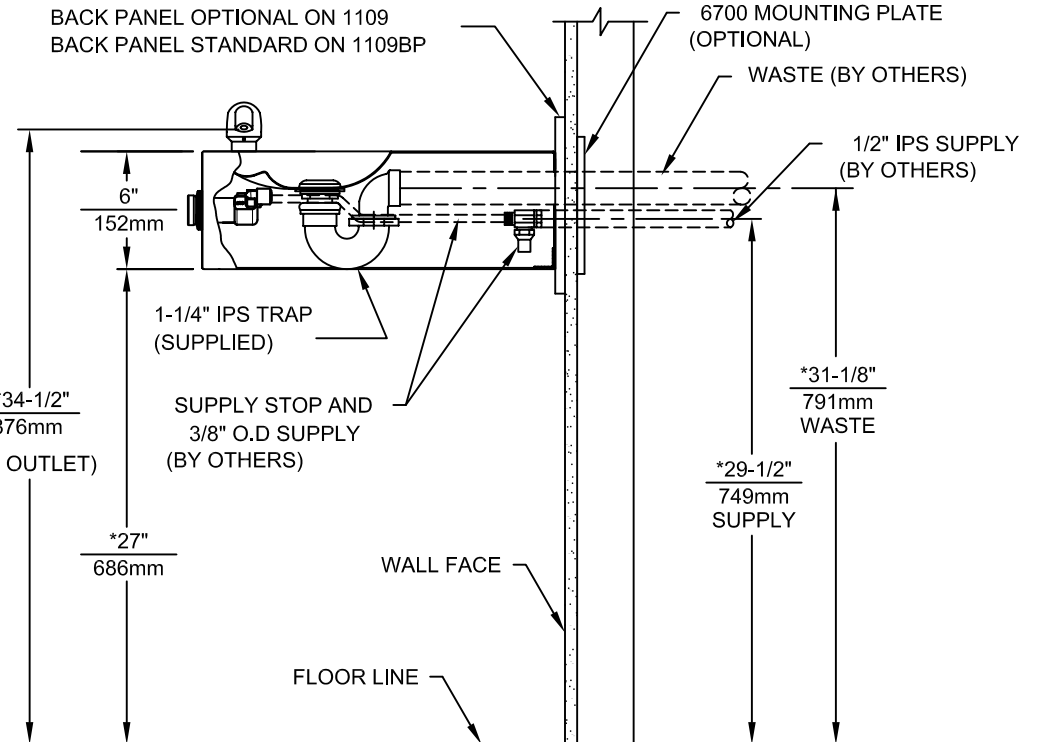

NOTES:

- HOLD ROUGH-IN DIMENSIONS ± 1/4" (6.4mm).
 - WHEN INSTALLING THIS UNIT LOCAL, STATE OR FEDERAL CODES SHOULD BE ADHERED TO. FOR INSTALLATION HEIGHTS OTHER THAN SHOWN, DIMENSIONS MARKED (*) MUST BE ADJUSTED ACCORDINGLY.
- 3 REFER TO 5874SS/VRK5874 OPERATION AND MAINTENANCE MANUAL FOR PUSH BUTTON AND VALVE INSTALLATION/MAINTENANCE INSTRUCTIONS.

		1455 KLEPPE LANE SPARKS, NEVADA 89431 (775) 359-4712 FAX (755) 359-7424 E-MAIL: HAWS@HAWS.CO.COM WEBSITE: WWW.HAWS.CO.COM	
ECN NO.:	REVISED PER BY:	MODEL(S)	PART NUMBER
ECN: 4565	HM	1109/1109BP	0002076620.D
DRAWN:	DATE:	CHKD.:	DRAWING NO. REV
F. VASQUEZ	03/96		13510A00 16
APPROVED:	DATE:	SCALE: 1:1	DRAWING TYPE: INSTALLATION
			SIZE: A SHEET 1 OF 1